

ROLLING SHUTTERS BLANK P.73

Description

One sheet shutter built with blank slats hooked one another obtained by profiling steel step P.73.
 Vertical sliding and to superior wrapping.
 With side stoppers, bottom slat height 100 mm with handle and gasket stops.
 Ample possibility of personalization with anti-noise system and insertion of elements for the airing.

Conforming to UNI EN 13241-1 

The shutters exposed to the wind, for instance in case of façade installation, they must have the Class 2 conforming with the EN 12424.

Characteristics and materials

Material		Galvanized steel	Galvanized steel	Steel AISI 316
Thickness	[mm]	0,8	1,0	0,6
Weight	[kg/m ²]	9,00	10,50	9,20
Max Width	[m]	5,00	5,00	5,00
Places of use		Garage - Shops - Various		

Dimensions

The values are approximates. For specific details contact our Technical Department.

In case of rotating shaft the minimum vertical space is 500 mm (motor + supports).



In case galvanized steel shutter thickness 0,8 mm or stainless steel AISI 316 thickness 0,8 mm with spring or octagonal shaft D.70, look at the table below; for spaces related to other thickness or material please contact our Technical Department.

H Heigh	B - Roll Diameter mm															
	Shaft with spring								Octagonal shaft D.70 with adapter D. 101							
5000	365	365	365	365	365	430	430	430	270	270	270	-	-	-	-	-
4500	350	350	350	350	350	350	410	410	260	260	260	-	-	-	-	-
4000	345	345	345	345	345	345	390	390	250	250	250	250	-	-	-	-
3500	335	335	335	335	335	335	370	370	230	230	230	230	-	-	-	-
3000	320	320	320	320	320	320	350	350	220	220	220	220	220	-	-	-
2500	300	300	300	300	300	300	330	330	210	210	210	210	210	210	-	-
2000	280	280	280	280	280	280	310	310	190	190	190	190	190	190	190	-
	1500	2000	2500	3000	3500	4000	4500	5000	1500	2000	2500	3000	3500	4000	4500	5000

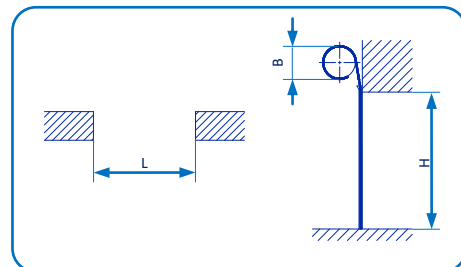
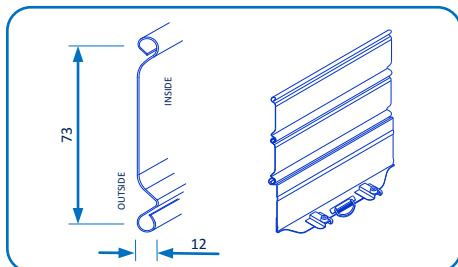



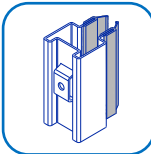
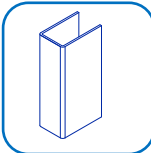

L – Length of the opening

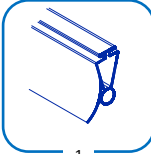
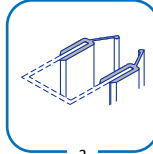
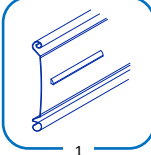
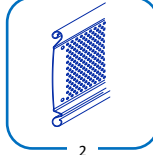
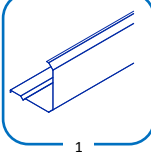
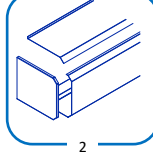
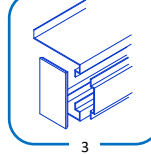
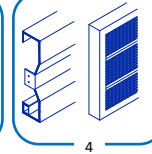

Guides

<p>Profiled guides in galvanized steel thickness 2,0 mm with gasket. For installation within and behind the opening</p>	
<p>U profiled guides in galvanized steel thickness 1,5 mm - 30 x 22 x 30 for widths until 2500 mm - 40 x 22 x 40 for widths until 4400 mm - 40 x 25 x 40 for widths until 4400 mm - 50 x 25 x 50 for widths until 5600 mm</p>	
<p>G profiled guides in galvanized steel thickness 2,0 mm - 60 x 60 – 80 x 60 – 80 x 80 – 100 x 80 - for shutters having a winding diameter higher than 450 mm - for installation behind the opening</p>	

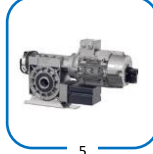
Accessories

Anti-noise system	
<ol style="list-style-type: none"> 1. Rubber Gasket applied to the bottom slat 2. Gasket in PVC 	 
Inserts for ventilation	
<ol style="list-style-type: none"> 1. Slats with hidden slots 85x5mm (ventilation 20 cm²/mt) Micro-perforated slat in galvanized steel with holes \varnothing 4mm 	 
Top and lid	
<ol style="list-style-type: none"> 1. Front panel 2. Carter composed by front panel, front upper and pair carter clips 3. Carter with removable front panel 4. External lid in galvanized sheet 	   
Automation	
<ol style="list-style-type: none"> 1. Manual operation for shaft with spring Round shaft \varnothing 48 – 60 – 76 – 89 – 101 2. Manual operation with torsional spring Octagonal shaft L. 70 – 102 3. Axial motor for shaft with spring Round shaft \varnothing 48 – 60 – 76 – 89 – 101 4. Tubular motor Octagonal shaft L. 70 5. Side motor Round shaft \varnothing 101 - 133 – 159 – 193 – 219 – 244 – 273 – 323 – 406 6. Forza motor Octagonal shaft L. 70 – 102 	     

Finish

Standard painting					
1000	Green beige	7004	Signal grey	8017	Chocolate brown
1001	Beige	7016	Anthracite grey	8019	Grey brown
1013	Oyster white	7021	Black grey	8024	Beige brown
1015	Light Ivory	7024	Graphite grey	9001	Cream
6005	Moss green	7040	Window grey	9002	Grey white
6009	Fir green	7046	Telegrey 2	9005	Jet black
6015	Black olive	7047	Telegrey 4	9010	Pure white
6019	Pastel green	8004	Copper brown	9011	Graphite black
6023	Mint green	8011	Nut brown	9016	Traffic white
7000	Squirrel grey	8014	Sepia brown		
7001	Silver grey	8016	Mahogany brown		

Special colours	
RAL 9006	Grey Arsonsisi
RAL colours not included in Standard painting	Metallic black
White: Marble (smooth) – Ancient marble (rough)	Black/ Brown: Sandy (rough)
Grey: Marble (smooth) - Ancient marble (rough)	Sandy 900
Brown: Marble (smooth) – Ancient Marble (rough)	Gunmetal
Green: Marble (smooth) – Ancient Marble (rough)	Gold color for external use
Red: Marble (smooth)	Hammered Brown for external use

The complete range of rolling shutter

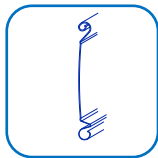

Blank P.115

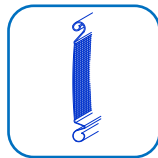

Micro-perforated P.115

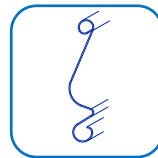

Blank P.97



Micro-perforated P.97

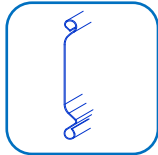

Blank P.73

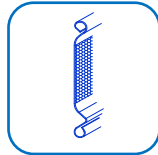

Micro-perforated P.73

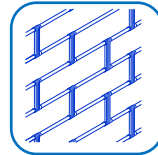

Tubular P.120

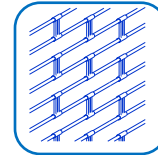

Tubular P.95

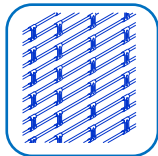

Tubular P.60

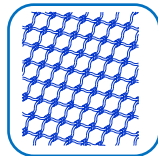

Tubonda

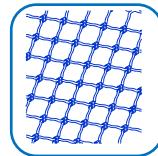

Tondino

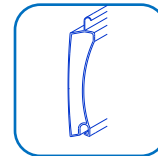

Insulated DP.77



Insulated DP.105

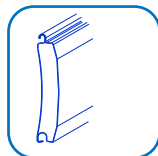

Insulated F.100

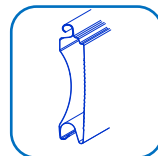

Insulated F.140

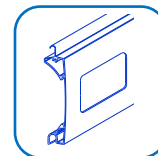

Windowed



Details and images in this leaflet are not binding.
Conegliano Serramenti s.r.l. reserve the right to modify them without notice at any time.

Conegliano Serramenti S.r.l

Via Campolongo 1/E Loc.Ramera Z.I. / 31010 Mareno di Piave – Treviso - Italy

Tel: +39 0438.4985 Fax: +39 0438.498540 / Web site: www.coneglianoserramenti.it www.forza-motion.com

P.I. e C.F.: 00532460268- N.Reg.Imp.di TV 8758 / Capitale Sociale i.v.: € 78.000,00 – Capitale esistente al 31.12.15 € 78.000,00i.v.